



**Certa-Set®  
LATERAL & MAINLINE CROP IRRIGATION SYSTEM PRODUCTS**

Certa-Set® PVC piping systems are ideally designed for use in agricultural irrigation including row crop, forage and nursery crop applications and work particularly well in drag, mechanical move and side-shift operations.

Agricultural growers around the world have come to recognize and appreciate Certa-Set for its easy to use (and re-use), leak-proof and corrosion-resistant design.



Short Form Specification	
Pipe Standard:	ASTM D2241
Diameter Std.:	Iron Pipe Size (IPS), Certa-Set 3" OD
Nominal Sizes:	3" OD, 6", 8", 10", 12"
Color:	Yellow
Fitting Compound:	ASTM D1784 Cell Class 12454 with Yelomine Technology
Pipe Joint Std.:	Gasketed – ASTM D3139 Solvent Weld – ASTM D2672
Gasket Standard:	ASTM F477
Certifications:*	NSF 61
Installation Standard:	ASTM D2774



\*Certa-Lok Sweeps are made from D2241/RJ pipe that additionally meets NSF 14.

Certa-Set Mainline PVC Pipe (includes Couplings, O-Rings and Splines)									
CLASS	NOM. SIZE	OUTSIDE DIAMETER (OD)	DR	MIN WALL THICKNESS (T1)	INTERNAL DIAMETER (ID)	WEIGHT (LB/FT)	PIPE LENGTH (FT)	APPROXIMATE LAY LENGTH WITH TAPPED COUPLING	PART NUMBER
125 PSI Main Line	6"	6.625"	32.5	0.204	6.217	2.69	20.0'	3.5"	32K06002031800
							32'-11.5"		3JK0600323180S
							40.0'		32K06004031800
							43.0'		3JK06004331800
	8"	8.625"	32.5	0.265	8.095	4.52	20.0'	3.5"	32K08002031800
							33.0'		3JK08003331800
							39'-8.5"		3JK08003931804
							40.0'		32K08004031800
	10"	10.750"	32.5	0.331	10.088	7.04	43.0'	4.0"	TBA
							20.0'		32K10002031800
							33.0'		32K10003331800
							39'-8"		3JK1000393180L
12"	12.750"	32.5	0.392	11.966	9.89	39'-10"	4.0"	32K1000393180P	
						19'-10.75"		32K1200193180Q	



**NorthAmericanPipe.com**

1.855.624.7473 AG-PS-005 0518

North American Pipe Corporation, a Westlake company

Copyright © 2018 North American Pipe Corporation. All rights reserved.



**Certa-Set®  
LATERAL & MAINLINE CROP IRRIGATION SYSTEM PRODUCTS**

Certa-Set Mainline PVC Pipe (includes Couplings, O-Rings and Splines)								
CLASS	NOM. SIZE	OUTSIDE DIAMETER (OD)	DR	MIN WALL THICKNESS (T1)	INTERNAL DIAMETER (ID)	WEIGHT (LB/FT)	PIPE LENGTH (FT)	PART NUMBER
100 PSI Main Line	6"	6.625"	41.0	0.163	6.299	2.17	20.0'	32M06002031800
							40.0'	3JM06004031800
	8"	8.625"	41.0	0.210	8.205	3.63	20.0'	3JM08002031800
							33.0'	3JM08003331800
							39'-8.5"	3JM08003931804
							40.0'	32M08004031800
	10"	10.750"	41.0	0.262	10.226	5.61	20.0'	3JM10002031800
							33.0'	3JM10003331800
							39'-8"	3JM1000393180L
							40.0'	3JM10004031800
	12"	12.750"	41.0	0.311	12.128	7.90	20.0'	3JM12002031800
							40.0'	3JM12004031800

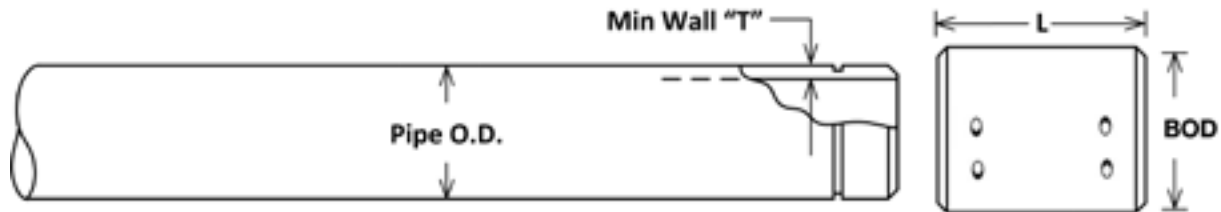

- NOTES**
1. Part numbers are of pipe.
  2. These dimensions are for estimating purposes only. All dimensions are in inches unless otherwise specified.
  3. DR = Dimension Ratio
  4. Maximum Pull Force based on actual testing and includes 2:1 safety factor.
  5. Internal diameter calculated using nominal outside diameter and minimum wall thickness.

**PRODUCT SPECIFICATION**





**Certa-Set®  
LATERAL & MAINLINE CROP IRRIGATION SYSTEM PRODUCTS**

<b>Certa-Set Mainline Accessories</b>					
<b>Dual Spline Hole Couplings</b>					
NOM. SIZE	PSI	BOD (IN.)	LENGTH	WEIGHT (LB)	COUPLING PART NUMBER
6.0	250	7.840	8.250	5.73	705199
8.0	125	10.190	10.125	11.82	716306
10.0*	250	12.438	12.125	18.93	740619
	125	12.440	16.00	25.48	740664
12.0*	250	14.648	12.125	25.30	740626
<b>Splines</b>					
NOM. SIZE	MATERIAL	SHAPE	CROSS SECTION (IN.)	LENGTH (IN.)	PART NUMBER
6.0	Nylon	Round	0.25	24	S0624RN0
8.0	Nylon	Square	.313 x .313	32	S0832SN1
10.0*	Nylon	Square	.313 x .313	20	S1020SN0
10.0***	Nylon	Square	.375 x .375	39	S1039SN0
12.0*	Nylon	Square	.313 x .313	24	S1224SN0
12.0***	Nylon	Square	.375 x .625	46	S1246TN0
<b>O-ring Gaskets</b>					
NOM. SIZE	MATERIAL	CROSS SECTION (IN.)	OUTSIDE DIAMETER (OD) (IN.)	PART NUMBER	
6.0	NBR	0.275	7.176	OR060YMNN	
8.0	NBR	0.375	9.350	OR080YMNI	
10.0*	IR/SBR	0.407	11.500	OR100YMNI	
12.0*	IR/SBR	0.407	13.500	OR120YMNI	

\*Couplings include 4 chamfered splines and 2 O-rings.  
 \*\*Single spline hole coupling.  
 \*\*\*For use with Mainline End Caps and Solvent Weld Adapter Fittings.

<b>Spline Insertion Tool (for faster and easier insertion of splines)</b>			
DESCRIPTION	NOM. SIZE	WEIGHT (LBS./PIECE)	PART NUMBER
Main Line	6"	2.25	707964
Main Line	8" - 12"	2.25	707971

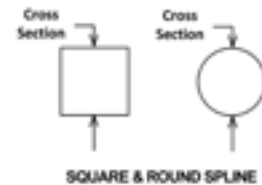
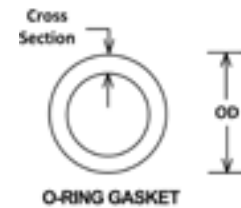
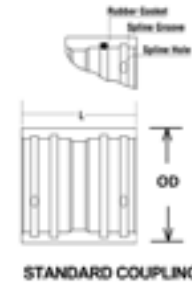

**PRODUCT SPECIFICATION**





**Certa-Set®  
LATERAL & MAINLINE CROP IRRIGATION SYSTEM PRODUCTS**

D2241 Certa-Lok Yelomine Sweeps – Certa-Lok Male x Certa-Lok Male										
NOM. SIZE	PRESSURE RATING (PSI)	CERTA-LOK GROOVE COMPATIBILITY		OUTSIDE DIAMETER (OD)	ANGLE (DEG)	BEND RADIUS (IN.)	L (IN.)	W (IN.)	WEIGHT (LB)	PART NUMBER
		D2241/RJ	D2241/RJIB							
6"	250	Yes**	Yes	6.625	22.5	21.000	28.962	5.761	12.3	710810
					45		39.181	16.229	18.5	710865
					90		42.007	42.007	30.9	710919
8"	250	Yes**	N/A	8.625	22.5	21.500	43.393	8.631	30.8	710827
					45		52.003	21.540	41.2	710872
					90		46.614	46.614	57.8	710926
10"	200	Yes	N/A	10.750	22.5	32.000	69.417	13.808	63.6	705236
					45		72.874	30.185	74.3	705250
					90		71.367	71.367	114.5	705267
12"	200	Yes	N/A	12.750	22.5	34.000	69.427	13.810	89.5	705243
					45		72.947	30.216	104.5	705274
					90		71.796	71.796	161.0	705281

\*\*Not compatible with D2241 Certa-Lok DR 12.43 pipe

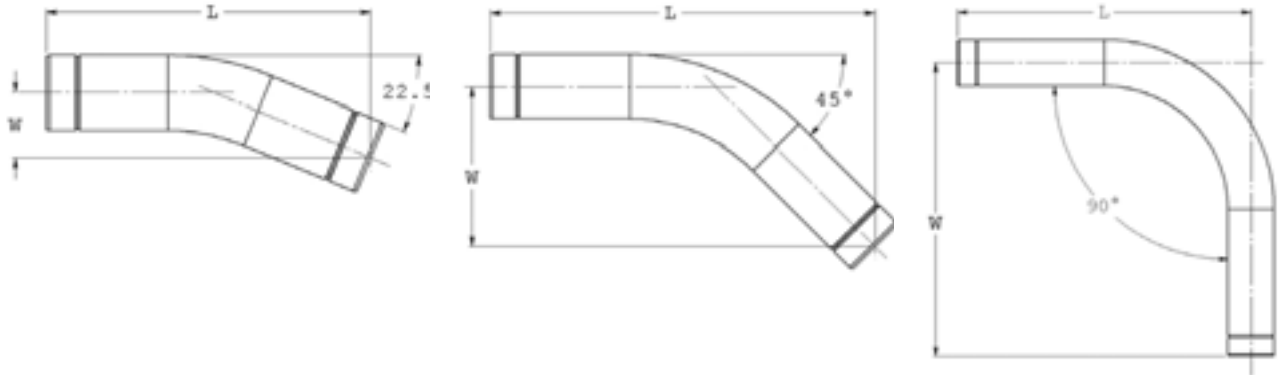

**NorthAmericanPipe.com**

1.855.624.7473 AG-PS-005 0518

North American Pipe Corporation, a Westlake company

Copyright © 2018 North American Pipe Corporation. All rights reserved.

**PRODUCT SPECIFICATION**



**Certa-Set®  
LATERAL & MAINLINE CROP IRRIGATION SYSTEM PRODUCTS**

**Main Line Plain End Tees**

SIZE	PRESSURE RATING (PSI)	WEIGHT (LBS./PIECE)	OD (IN.)	LENGTH (IN.)	F (IN.)	PART NUMBER
6	250	25	6.625	31	15.5	704635
8	250	48	8.625	36.25	17.75	704642
10	200	81.52	10.75	45.38	22.7	704581
12	160	125.63	12.75	45	22.5	745522

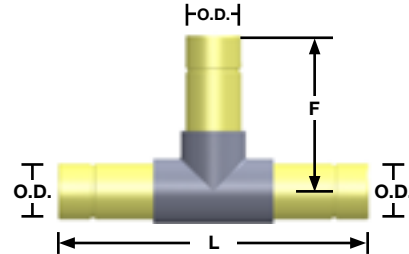

**Main Line Plain End Elbows**

SIZE	PRESSURE RATING (PSI)	WEIGHT (LBS./PIECE)	OD (IN.)	LENGTH (IN.)	PART NUMBER
6	250	17.4	6.625	15.75	704895
8	250	33.7	8.625	17.75	704901
10	200	59.66	10.75	21.78	704765
12	160	99.28	12.75	22.88	745515

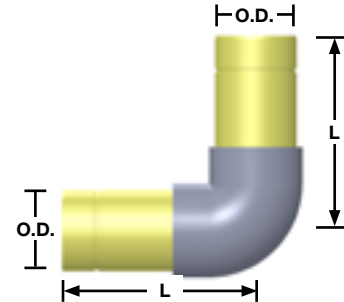

**Main Line End Caps**

SIZE	PRESSURE RATING (PSI)	WEIGHT (LBS./PIECE)	OD (IN.)	LENGTH (IN.)	PART NUMBER
6	250	9.000	7.840	9.000	700019
8	250	17.000	10.190	10.130	700026
10	200	22.000	12.440	12.130	700033
12	160	28.000	14.650	12.130	745508

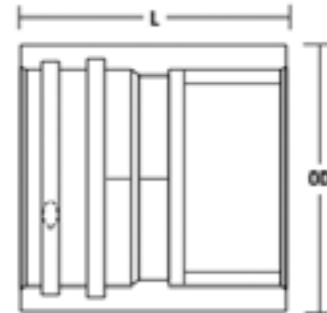

**PRODUCT SPECIFICATION**





**Certa-Set®  
LATERAL & MAINLINE CROP IRRIGATION SYSTEM PRODUCTS**

**D2241 Certa-Lok Yelomine Solvent Weld IPS Adapters – Certa-Lok Female x IPS Solvent Weld Female**

NOM. SIZE	PIPE OUTSIDE DIAMETER	PRESSURE RATING (PSI)	CERTA-LOK GROOVE COMPATIBILITY		BOD (IN.)	L (IN.)	L <sub>2</sub> (IN.)	WEIGHT (LB)	PART NUMBER				
			D2241/RJ	D2241/RJIB					PERMANENT USE		NON-PERMANENT USE		SPLINE
									FITTING*	O-RING	FITTING*	O-RING	
6"	6.625	250	Yes**	Yes	7.840	9.000	4.100	6.4	715389	OR060YMPI	705380	OR060YMNN	S0624RN0
		315	Yes**	Yes	8.366	11.250	6.100	11.9	10558	OR060YMPI	-	-	S0624RN0
8"	8.625	250	Yes**	Yes	10.190	10.125	4.600	12.0	715396	OR080YMPI	705397	OR080YMNI	S0832SN1
		315	Yes**	Yes	10.947	11.750	6.100	21.5	10560	OR080YMPI	-	-	S0832SN1
10"	10.750	200	Yes	N/A	12.438	12.125	5.850	19.3	715082	OR100YMPI	705083	OR100YMNI	S1039SN0
12"	12.750	200	Yes	N/A	14.648	12.125	5.850	25.5	715099	OR120YMPI	705090	OR120YMNI	S1246TN0

\* Includes permanent or non-permanent style gasket as applicable and spline  
 \*\*Not compatible with D2241 Certa-Lok DR 12.43 pipe

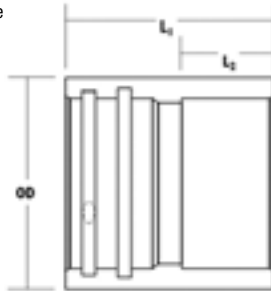

**Certa-Lok Male x IPS Solvent Weld Female**

NOM. SIZE	PIPE OUTSIDE (IN.)	PRESSURE RATING (PSI)	CERTA-LOK GROOVE COMPATIBILITY		L (IN.)	L <sub>2</sub> (IN.)	WEIGHT (LB)	PART NUMBER
			D2241/RJ	D2241/RJIB				
6"	6.625	250	Yes**	Yes	11.375	4.500	5.3	705335
8"	8.625	250	Yes**	Yes	12.875	4.500	9.0	705342
10"	10.750	200	Yes	N/A	15.250	6.000	11.0	705168
12"	12.750	200	Yes	N/A	15.250	6.000	15.0	705175

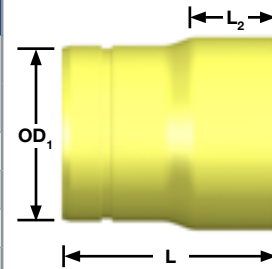



**Certa-Set®  
LATERAL & MAINLINE CROP IRRIGATION SYSTEM PRODUCTS**

**PRODUCT SPECIFICATION**

D2241 Certa-Lok Yelomine Tapped Couplings – Certa-Lok Female x Certa-Lok Female x NPT Tapped Hole												
NOM. SIZE	PIPE OUTSIDE DIAMETER (IN.)	TAPPED HOLE SIZE (IN.)	NUMBER OF TAPS	PRESSURE RATING (PSI)	CERTA-LOK GROOVE COMPATIBILITY		BOD (IN.)	L (IN.)	WEIGHT (LB)	PART NUMBER		
					D2241/RJ	D2241/RJIB				NON-PERMANENT USE		SPLINES
										FITTING*	O-RING	
6"	6.625	3/4" NPT	Single Tap	200	Yes**	Yes	7.840	11.250	8.1	705434	OR060YMNN	S0624RNO
		1" NPT	Single Tap	200	Yes**	Yes	7.840	11.250	8.1	705496		
		1-1/2" NPT	Single Tap	200	Yes**	Yes	7.840	11.250	8.1	705502		
		1-1/2" NPT	Single Tap	250	Yes**	Yes	8.366	11.250	11.9	706592		
		2" NPT	Single Tap	160	Yes**	Yes	7.840	11.250	8.0	705540		
		2" NPT***	Single Tap	160	Yes**	Yes	7.840	11.250	8.0	709555		
		2" NPT***	Double Tap	160	Yes**	Yes	7.840	11.250	7.6	709562		
		3" NPT***	Single Tap	160	Yes**	Yes	8.366	12.250	12.5	709500		
3" NPT	Double Tap w/ 2" Single Tap	160	Yes**	Yes	8.366	12.250	11.9	715785		S0624SNO		
8"	8.625	1" NPT	Single Tap	200	Yes**	Yes	10.190	12.500	15.1	705519	OR080YMNI	S0832SN1
		1-1/2" NPT	Single Tap	200	Yes**	Yes	10.190	12.500	15.0	705526		
		1-1/2" NPT	Single Tap	250	Yes**	Yes	10.947	12.500	22.9	715778		
		2" NPT	Single Tap	160	Yes**	Yes	10.190	12.500	15.0	705533		
		3" NPT	Single Tap	130	Yes**	Yes	10.190	13.500	16.1	705588		
		3" NPT***	Single Tap	130	Yes**	Yes	10.190	12.500	15.5	709593		
		3" NPT***	Single Tap	125	Yes**	Yes	10.190	12.500	15.5	716308		
		3" NPT***	Double Tap	130	Yes**	Yes	10.190	13.500	15.1	715747		
		3" NPT***	Double Tap	130	Yes**	Yes	10.190	13.500	15.1	716307		
3" NPT***	Double Tap w/ 2" Single Tap	130	Yes**	Yes	10.190	13.500	14.9	716706		S0832SNO		
10"	10.750	1-1/2" NPT	Single Tap	200	Yes**	N/A	12.438	15.000	23.8	707858	OR100YMNI	S1039SNO
		2" NPT	Single Tap	125	Yes**	N/A	12.438	15.000	22.9	709685		S1039SNG
		3" NPT***	Single Tap	125	Yes**	N/A	12.438	16.000	24.4	727917		S1020SNO
		3" NPT***	Double Tap	125	Yes**	N/A	12.438	16.000	24.0	725760		
		3" NPT***	Double Tap w/ 2" Single Tap	125	Yes**	N/A	12.438	16.000	23.8	727924		
		4" NPT***	Single Tap	125	Yes**	N/A	12.438	16.000	24.2	745430		S1039SNG
12"	12.750	2" NPT	Single Tap	160	Yes**	N/A	14.648	15.000	31.8	707803	OR120YMNI	S1246TNO
		3" NPT***	Single Tap	125	Yes**	N/A	14.648	16.000	32.7	709708		S1224SNO
		3" NPT***	Double Tap	125	Yes**	N/A	14.648	16.000	32.3	709746		

\* Includes non-permanent style o-ring and spline  
 \*\*Not compatible with D2241 Certa-Lok DR 12.43 pipe  
 \*\*\*2 Spline Hole Coupling

**NOTES**

1. These dimensions are for estimating purposes only. All dimensions are in inches unless otherwise specified.
2. ASTM Pressure Rating @ 73°F and includes 2:1 safety factor.
3. Expansion couplings do not provide a fully restrained joint.
4. Non-permanent gaskets are typically used in temporary bypass applications that require disassembly and reuse of the joint. They should never be specified for permanent, buried, or submerged applications. Permanent gaskets are slightly larger and make disassembly of the joint more difficult. They are intended for all installations that do not require disassembly during the system's service life including buried installation, river and road crossings, and all installations that would expose joints to long-term or excessive misalignment due to external loads. If in doubt as to which gasket should be chosen, consult your North American Pipe Corporation Sales Representative or Technical Services Group.

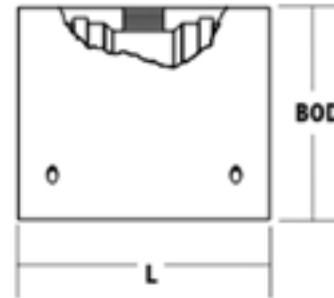

**NorthAmericanPipe.com**

1.855.624.7473 AG-PS-005 0518

North American Pipe Corporation, a Westlake company  
 Copyright © 2018 North American Pipe Corporation. All rights reserved.



**Certa-Set®  
LATERAL & MAINLINE CROP IRRIGATION SYSTEM PRODUCTS**

**Valve Transition Fittings**

CONFIGURATION	PSI	LENGTH	WEIGHT (LB./PC.)	PART NUMBER
3" IPS Certa-Set Male X 3" IPS MIPT	125	6.00"	0.91	706790
3" IPS Certa-Set Male X 3" IPS MIPT	125	12.00"	1.88	010524
3" IPS Certa-Set Male x 3" IPS MIPT	125	18.00"	2.86	010525

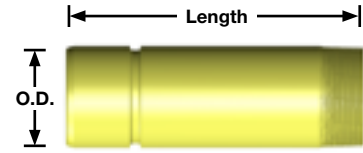

**NOTE**  
3" Certa-Set = 3.00" , 3" IPS = 3.50"

**IPS Certa-Lok Male x IPS Male Plain End Nipples**

SIZE	PRESSURE RATING	WEIGHT (LBS./PIECE)	OD	LENGTH	PART NUMBER
6	250	5.4	6.625	12	705878
8	250	8.32	8.625	13	705885
10	200	13.99	10.75	16	706325
12	160	19.74	12.75	16	706332

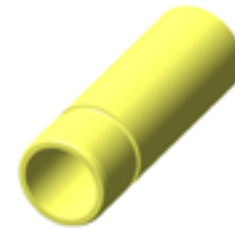

**Certa-Lok IPS Male X IPS MIPT Nipples**

SIZE	PRESSURE RATING	WEIGHT (LBS./PIECE)	OD	LENGTH	PART NUMBER
6	140	5.29	6.625	12	706028
8	120	8.65	8.625	13	706035

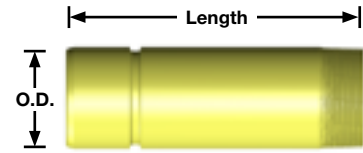

**Certa-Lok IPS Female X Flange Adapters**

SIZE	PRESSURE RATING	WEIGHT (LBS./PIECE)	OD 1 (IN.)	OD 2 (IN.)	LENGTH (IN.)	BOLT CIRCLE DIAMETER (IN.)	NUMBER OF BOLT HOLES	PART NUMBER
6	150	9	6.625	11	12.44	9.5	8	705779
8	150	16	8.625	13.5	13.38	11.75	8	705786
10	150	25.4	10.75	16	16.69	14.25	12	707773
12	150	36.7	12.75	19	16.63	17	12	707780

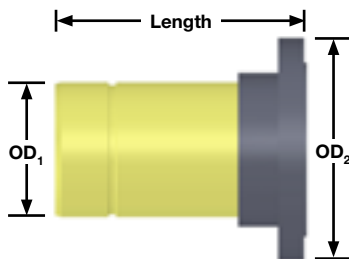





**Certa-Set®  
LATERAL & MAINLINE CROP IRRIGATION SYSTEM PRODUCTS**

Certa-Set Lateral Sprinkler Pipe								
SIZE	PRESSURE RATING (PSI)	OD (IN.)	WEIGHT (LBS./FT.)	LENGTH/PART NUMBER				
				15 FT.	19 FT.	20 FT.	30 FT.	40 FT.
3"	125	3.00"	0.80	32903001533800	32903001933800	329030020338000	32903003033800	32903004033800

Certa-Set Sled Coupling Kit		
Sled Coupling Kit Part Number	700606	
COMPONENT PART	QUANTITY INCLUDED IN KIT	COMPONENT PART NUMBER
Sled Coupling	1	700477
Spline	2	S03CSET0
O-ring	2	OR030CSON

Certa-Set Sled Coupling					
PRESSURE RATING (PSI)	LENGTH (IN.)	WIDTH (IN.)	WEIGHT (LBS./PIECE)	BOD (IN.)	PART NUMBER
125	7.5	6	1.4	3.625	700477*

\*Does not contain o-ring gaskets and splines. For complete kit including sled coupling, 2 o-ring gaskets and 2 splines, order part number 700606

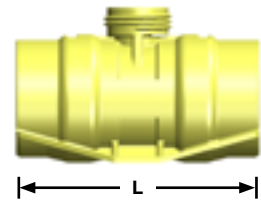
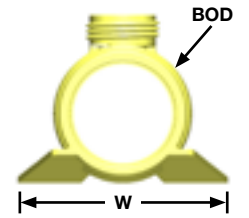

**PRODUCT SPECIFICATION**





**Certa-Set®  
LATERAL & MAINLINE CROP IRRIGATION SYSTEM PRODUCTS**

Certa-Set Tee Assembly Kit		
Tee Assembly Kit Part Number	716226	
COMPONENT PART	QUANTITY INCLUDED IN KIT	COMPONENT PART NUMBER
Tee	1	MP50868
Spline	3	S03CSET0
O-ring	3	OR030CSON

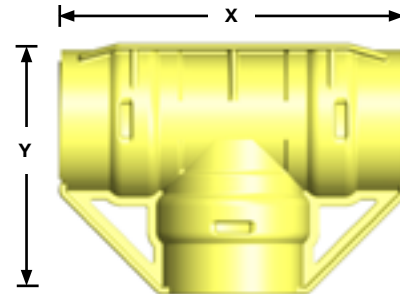

Certa-Set Tee				
PRESSURE RATING	LENGTH (X) (IN.)	WIDTH (Y) (IN.)	WEIGHT (LBS./PIECE)	PART NUMBER
125	9	6.48	2.58	82157716226

\*Does contain o-ring and splines. For complete kit including Tee, 3 o-ring and 3 splines.

Certa-Set Tee & Sled Coupling Spline				
DESCRIPTION	NOM. SIZE	LENGTH (IN.)	CONFIGURATION	PART NUMBER
Certa-Set	3"	12"	Serrated	S03CSET0

Gaskets/O-Ring				
DESCRIPTION	SIZE	MATERIAL	PART NUMBER	
Certa-Set 1/2" Chevron Gasket	1/2"	NBR	GSP6030300	
Certa-Set 3" OD O-Ring	3"	NBR	OR030CSON	
Certa-Set 3/4" Flange Gasket	3/4"	NBR	GSP6030075	



Riser Pipe Stock						
SIZE	PRESSURE CLASS	OD (IN)	MIN WALL THICKNESS (IN)	WEIGHT (LBS./FT.)	LENGTH (FT.)	PART NUMBER
3/4"	Sch. 80	1.05	0.28	0.28	12	32T07501271800





**Certa-Set®**  
**LATERAL & MAINLINE CROP IRRIGATION SYSTEM PRODUCTS**

Certa-Set Riser Sled Components				
DESCRIPTION	CONFIGURATION	PRESSURE RATING (PSI)	WEIGHT (LBS./PIECE)	PART NUMBER
Riser Cap	1/2" Single Hook Riser Cap	125	0.10	700361
Riser Cap	3/4" Riser Cap*	125	0.13	700347
Sprinkler Adapter	3/4" Nelson Sprinkler Adapter	125	0.05	862861
Kit - Cap	Kit - 1/2" Cap (Single Hook Cap and Chevron Gasket)	125	0.10	700613
Assembled Riser	3/4" x 12" (includes sled cap, flange o-ring, 1/2" Nelson Acme Adapter)	125	0.46	716300
Assembled Riser	3/4" x 18" (includes sled cap, flange o-ring, 1/2" Nelson Acme Adapter)	125	0.90	862519
Assembled Riser	3/4" x 24" (includes sled cap, flange o-ring, 1/2" Nelson Acme Adapter)	125	1.20	862540
Assembled Riser	3/4" x 30" (includes sled cap, flange o-ring, 1/2" Nelson Acme Adapter)	125	1.50	862618
Assembled Riser	3/4" x 36" (includes sled cap, flange o-ring, 1/2" Nelson Acme Adapter)	125	1.80	682885



\*Note: Sold only with assembled riser. Individual sales opportunities must be discussed with Territory and Sales Managers.

PRODUCT SPECIFICATION



**NorthAmericanPipe.com**

1.855.624.7473 AG-PS-005 0518

North American Pipe Corporation, a Westlake company

Copyright © 2018 North American Pipe Corporation. All rights reserved.



**Certa-Set®  
LATERAL & MAINLINE CROP IRRIGATION SYSTEM PRODUCTS**

<b>Certa-Set Lateral Fittings</b>						
DESCRIPTION	IMAGE	CONFIGURATION	PSI	LENGTH	WEIGHT (LBS./PIECE)	PART NUMBER
Sled Coupling		3" Certa-Set Female X 3" Certa-Set Female	125	7.50	1.40	700606
Tee Assembly		3" Certa-Set Female X 3" Certa-Set Female	125	9.00	2.58	716226
End Plug		3" Certa-Set Male	125	5.90	0.50	745745
Adapter Nipple		3" Certa-Set Male X 3" IPS Plain End	125	6.50	1.38	700392
		3" Certa-Set Male X 3" IPS Plain End	125	8.00	1.95	745348
Adapter Nipple		3" IPS MNPT X 3" Certa-Set Male	125	8.00	1.17	745331
Nipple		3" Certa-Set Male X 3" Certa-Set Male	125	5.75	0.70	745737
Nipple		3" Certa-Set Female X 3" IPS MIPT	125	3.75	0.67	745669
Nipple		3" Certa-Set Female X 3" IPS Plain End	125	3.75	0.80	715907



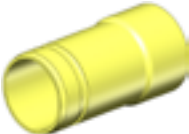

**Certa-Set®**  
**LATERAL & MAINLINE CROP IRRIGATION SYSTEM PRODUCTS**

Certa-Set Lateral Fittings						
DESCRIPTION	IMAGE	CONFIGURATION	PSI	LENGTH	WEIGHT (LBS./PIECE)	PART NUMBER
Nipple		3" Certa-Set Male X 3" Certa-Set Plain End	125	6.50	0.50	700385
Coupling		3" Certa-Set Female X 3" Certa-Set Female	125	5.25	0.65	715204
Coupling		Certa-Set Solvent Weld Coupling	125	6.00	0.45	715969
Flange		3" Certa-Set Female X Flange	125	5.25	3.10	715952
Adapter Nipple		3" Certa-Set Male X 2½" Solvent Weld Bell Adapter	125	6.25	0.60	715921
Pipe Repair Fitting		3" Certa-Set Male X 3" Solvent Weld Bell Adapter	125	11.75	0.90	715877

PRODUCT SPECIFICATION



**Certa-Set®  
LATERAL & MAINLINE CROP IRRIGATION SYSTEM PRODUCTS**

<b>Packaging and Weights</b>											
SIZE	TYPE	PIPE LAY LENGTH (FT.)	LAY LENGTH W/3" TAP COUPLING	PRESSURE RATING (PSI)	APPROX. WEIGHT (LBS./FT.)	FEET PER FAST-PAK	APPROX. WEIGHT (LBS./FAST-PAK)	FAST-PAKS PER TRUCK LOAD	FEET PER TRUCK LOAD	FAST PAK % OF TRUCK LOAD	PART NUMBER
3/4"	Certa Set Riser Stock	12'	N/A	690	0.28	8,000	2,256	21	168,000	4.76	32T07501271800
3"	Certa-Set	15'	15'-1-3/4"	125	0.80	1,095	696	28	30,660	3.13	32903001533800
		19'	19'-1-3/4"			1,387	882	28	38,836	3.13	32903001933800
		20'	20'-1-3/4"			1,460	928	28	40,880	3.57	32903002033800
		30'	30'-1-3/4"			2,190	1,392	14	30,660	7.14	32903003033800
		40'	40'-1-3/4"			2,920	1,856	14	40,880	7.14	32903004033800
6"	Certa-Set Class 125 Main Line	20'	20'-4"	125	2.69	400	1,076	20	8,000	5.00	32K06002031800
		32'-11-1/2"	33'-3-1/2"			659.2	1,774	10	6,592	10.00	3JK0600323180S
		40'	40'-4"			800	2,153	10	8,000	10.00	32K06004031800
		43'	43'-4"			860	2,314	10	8,600	10.00	3JK06004331800
	Certa-Set Class 100 Main Line	20'	20'-4"	100	2.17	400	869	20	8,000	5.00	3JM06002031800
		40'	40'-4"			800	1,738	10	8,000	10.00	3JM06004031800
8"	Certa-Set Class 125 Main Line	20'	20'-3-1/2"	125	4.48	280	1,254	16	4,480	6.25	32K08002031800
		33'	33'-3-1/2"			462	2,069	8	3,696	12.50	3JK08003331800
		39'-8-1/2"	40'			555.9	2,489	8	4,447.2	12.50	3JK08003931804
		40'	40'-3-1/2"			560	2,508	8	4,480	12.50	32K08004031800
	Certa-Set Class 100 Main Line	20'	20'-3-1/2"	100	3.64	280	1,018	16	4,480	6.25	3JM08002031800
		33'	33'-3-1/2"			462	1,679	8	3,696	12.50	3JM08003331800
		39'-8-1/2"	40'			555.9	2,021	8	4,447.2	12.50	3JM08003931804
		40'	40'-3-1/2"			560	2,036	8	4,480	12.50	32M08004031800
10"	Certa-Set Class 125 Main Line	20'	20'-4"	125	7.00	160	1,121	18	2,880	5.56	32K10002031800
		33'	33'-4"			264	1,849	9	2,376	11.00	32K10003331800
		39'-8"	40'			317.4	2,223	9	2,856.6	11.11	3JK1000393180L
		39'-10"	40'-2"			318.6	2,231	9	2,867.4	11.11	32K1000393180P
	Certa-Set Class 100 Main Line	20'	20'-4"	100	5.62	160	899	18	2,880	5.56	3JM10002031800
		33'	33'-4"			264	1,484	9	2,376	11.00	3JM10003331800
		39'-8"	40'			317.4	1,784	9	2,856.6	11.11	3JM1000393180L
		40'	40'-4"			320	1,798	9	2,880	11.11	3JM10004031800
12"	Certa-Set Class 125 Main Line	19'-10-3/4"	20'-2-3/4"	125	9.84	159.2	1,566	14	2,228.8	7.14	32K12001931800
	Certa-Set Class 100 Main Line	20'	20'-4"	100	7.92	160	1,266	14	2,240	7.14	3JM12002031800
		40'	40'-4"			320	2,533	7	2,240	3.75	3JM12004031800





## Certa-Set® LATERAL & MAINLINE CROP IRRIGATION SYSTEM PRODUCTS

- Use of spline insertion tools will greatly speed the assembly and disassembly of main lines. **CAUTION** – Use of vice grips or pliers for spline insertion may notch the spline, which may cause premature breakage in the coupling during disassembly.
- Although all rings are Teflon coated to ease assembly and disassembly, CertainTeed recommends that a small amount of pipe lubricant be applied to the rubber O-Rings and pipe ends when assembling Certa-Set pipe.  
**Important – At no time should any oil-based lubricant be applied to the spline or placed in the spline groove. Oil-based lubricants placed in those areas will reduce the strength of the restrained joint and potentially cause the spline to swell, causing premature breakage.**
- The Certa-Set solid set system is designed to use rotator sprinklers installed on risers. You may use Certa-Set risers safely for this application.
- All 1/2" riser stubs below the quick disconnect hook must be minimum 2.25" in length to ensure full engagement of the riser Chevron seal to prevent water leakage and to ensure full engagement of the coupling boss for proper riser support. Riser OD shaft specification  $.840 \pm .010$ ". Maximum height for the riser is 36 inches when used with rotator sprinklers and 24 inches when used with impact sprinklers. When using a riser that is higher than the dimensions mentioned above it is recommended that stakes be utilized to stabilize the system.
- **CAUTION** – If farm implements are intended to be driven over the Certa-Lok Class 125 Main Line pipe, the pipe must be installed in V-cut trench, which covers at least 3/4 of the pipe diameter. Under no circumstances should any farm implement be driven over the 3" lateral or Certa-Set Class 100 Main Line pipe. Care should be taken to avoid pipe external loading or impacting with any equipment that would lead to a permanent deformation.
- Certa-Set pipe and sled coupling may be mechanically shifted. The rollers and guides must provide an uninterrupted passage of pipe and couplings. Rollers and guides need to be manufactured from materials such as rubber Yelomine or urethane, which exhibit absorptive properties. There must be no knocking or abrupt contact with the couplings during shifting.
- To repair Certa-Set lateral pipe broken ends, first make a square cut on the broken pipe end to ensure proper alignment in the repair fitting. Solvent weld Part Number 715877, Certa-Set Male x Solvent Weld Bell, onto the cut end of the pipe. To repair breaks in the middle of the pipe, make a square cut on both of the broken pieces and solvent weld both cut ends into Part Number 715969, Certa-Set Solvent Weld x Solvent Weld Coupling.
- The 6" Class 125 Main Line is produced with thickened ends to accommodate the Certa-Lok groove while maintaining the designed pressure rating. Grooving the non-thickened pipe body will result in less than designed pressure rating for the new joint and ultimately the entire system. When fabrication is required for 6" Class 125, apply a Certa-Set by solvent weld coupling or a Certa-Set adapter.
- Transition from the Certa-Set Main Line to the Certa-Set lateral line can be made via a Certa-Lok Main Line tapped coupling and a 3" Certa-Lok Male x Male Pipe Thread Nipple (CertainTeed Part No. 745652), or one can transition from the main line by installing a male pipe thread ball valve directly into the Certa-Lok tapped coupling.

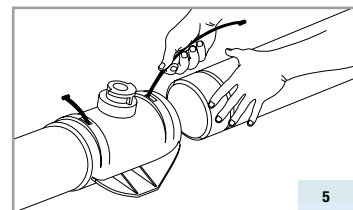
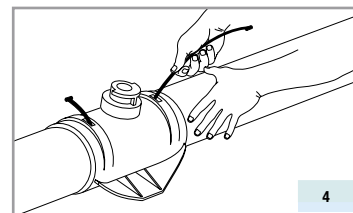
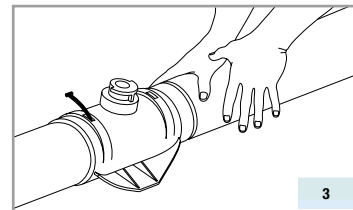
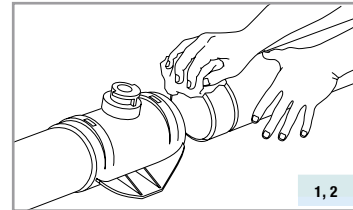

1. Clean joining surfaces.
2. Apply lubricant to rubber rings and pipe ends.
3. Align and insert pipe into Certa-Lok or Certa-Set coupling and push home. When the pipe-end seats against the coupling stop, the locking grooves are automatically aligned for spline insertion.
4. The spline is then inserted through the insertion hole in the coupling until it is fully seated. This securely locks the coupling to the pipe. The gasket provides a hydraulic seal. No insertion tool is needed.
5. When needed, the joint can be disassembled and reused.





## Certa-Set® LATERAL & MAINLINE CROP IRRIGATION SYSTEM PRODUCTS

Certa-Set Main Line and Lateral Pipe Flow Performance Data									
SIZE	CERTA-SET MAIN LINE (CLASS 125)				CERTA-SET MAINLINE EMERALD (CLASS 100)				CERTA-SET LATERAL (CLASS 125)
	6"	8"	10"	12"	6"	8"	10"	12"	3"
Maximum I.D. (in.)	6.217	8.094	10.088	11.965	6.299	8.204	10.226	12.128	2.732
GPM*	473	802	1246	1752	485	824	1280	1800	91
Friction Flow Loss (FT. H2O/1000 ft.)	12.184	8.969	6.944	5.696	11.725	8.829	6.836	5.607	31.67

### Important Certa-Set Application Limitations

North American Pipe Corporation offers a seven-year limited warranty on 3" Certa-Set pipe and sled couplings. Please note the following pertinent application limitations:

1. Certa-Set lateral piping has been designed for drag applications where the tensile pull must not exceed 3,500 lbs. Exceeding 3,500 lbs. pull will stress the pipe at the spline groove, resulting in spline override and possible premature pipe or coupling breakage.
2. All risers must be removed from the couplings prior to drag movement in heavy foliage installations, as under certain crop conditions, foliage can become entangled with the risers, resulting in excessive deflection (stress) on the coupling boss during movement. Any excessive deflection can result in possible breakage at the coupling boss.
3. Water needs to be drained from the 3" lateral pipe before drag or mechanical retrieval. Failure to do so will result in spline override, with resulting coupling damage. Also, failure to drain water in drag applications will cause severe abrasion to the sled coupling and pipe over time. To remove water, simply remove the Certa-Set end plug (Part No. 745607) and allow the water to drain. It is not required to drain the water when performing a lateral mechanical shift of up to 20 feet.
4. During mechanized lateral movement of the 3" Certa-Set pipe, pipe offset must not exceed 40 inches per 20 feet of pipe. Exceeding this level will place excessive stress on the sled coupling at the spline groove, resulting in premature coupling breakage.
5. **CAUTION** – Under no circumstances should any farm implement (tractor, mower, etc.) be used to impact the coupling or pipe for the intended purpose of lateral or directional movement. Additionally, no farm implements are to be driven over the 3" lateral pipe.
6. North American Pipe Corporation will not assume any responsibility or liability for damage directly or indirectly resulting from the failure to serve the intended purpose of any component, such as saddles, which are used to modify our standard products.

### Additional Resources

[Certa-Set Field Installation Guide](#)

[Certa-Set Website](#)

[Certa-Set YouTube Channel](#)



NorthAmericanPipe.com

1.855.624.7473 AG-PS-005 0518

North American Pipe Corporation, a Westlake company  
Copyright © 2018 North American Pipe Corporation. All rights reserved.